

# INSTALLATION INSTRUCTION

## Outdoor spa

MODEL : WS-095B



Sanitary Ware Expert,  
Your best choice!

- No advanced advice will be submit before we change our design and size.
- The pictures maybe a little different from the real products.
- Our company keep the final explanation right.



**Do not dispose this product as unsorted municipal waste. Collection of such waste separately for special treatment is necessary.**

**Dear user,**

**Thank you very much for purchasing our sanitary ware. To enable you to use this product safely and effectively, please read this installation and operation manual carefully before use.**

## **Cautions**

1. Please connect the water pipe before installed the products. (Fig.1)
2. Please ensure that the product installed reliable electric leakage protection device, the power plug contains earth line, and make sure it is reliable earthing. Check the protect system of leakage protection each time before use.
3. Before turn on water pump, check if the water level over jets 10 to 20 mm or not, make sure regular usage of water pump otherwise it will be destroy because of water leakage.
4. Do not turn on water pump, heat pump or air bubble pump without water.
5. People with Hypertension symptom, after drink or heart disease are not allowed to use the bathtub. Children have a bath must under adult's guidance.
6. During use please noticed that don't blocked the jets and avoiding the air adjustment valve overflowing. Also keep the bathtub clean and don't let it blocked by hair or mess.
7. During use, please firstly adjust the water temperature or it will be burned.
8. The outdoor spa is designed with ergonomic, rise and fall changes are quite big so during use pay more attention of being slipped.
9. Please shut down the system when not to use.

## Cleaning and Maintenance

1. The daily maintenance of outdoor spa should be cleaned with ordinary detergent and soft cloth. Please do not use the detergent which contains acetone or ammonia liquid. If there are marks or something like glue on the surface of bathtub, just polish it with soft cloth dipping with gas.
2. If there are scratches on bathtub surface, please polish it with 1500# frosted paper dipping with liquid and burnish it with toothpaste. It will be shining again after that.
3. If there are furring on the surface of bathtub, it can be taken away by mild acid detergent, for example wipe the bathtub with lemon juice or vinegar which is heated.
4. Do not wipe the chrome plated spare parts all the time, and do not get in touch with chemical detergent etc. Otherwise the surface of chrome plated will be destroyed. The product should be cleaned by soft cloth other than coarse cloth.
5. To check the water pipe regularly in order to avoid troubles from cracks of water pipes or blocked inside.
6. If there are something such as hair stuck inside the jets, then just twist out the jets and remove it.
7. To clean hydro-massage equipment: To full fill hot water which is 40°C, and pour 2g/L detergent, start hydro-massage function more than 5 minutes, then turn off the massage function and drain out the water. Next, to full fill cold water and start hydro-massage function for 3 minutes, then turn off the massage function and drain out the water, at last, to dry the bathtub with towel.
8. Filter should be cleaned once a week.
9. Keep out from combustibles and goods which over 80° C to avoid fire disaster and damage the product.
10. The bathtub should be transported carefully. Do not lay heavy things on it and do not bump and shake the tub. If the bathtub has not been used for a long time, drain out the water of the bathtub and keep it in a dry and ventilated environment. Avoid corrosive gas.

## Filter Cleaning

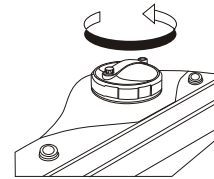

1、 Twist the exhaust valve withershins.

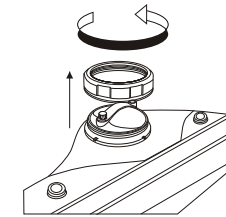

2、 Twist the fixed nut withershins to pull it up.

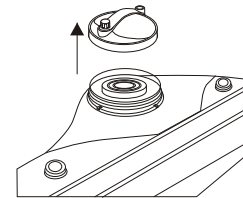

3、 Pull out the hermetic cover .

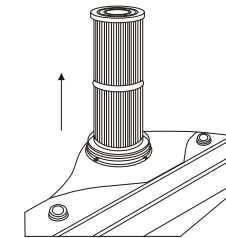

4、 Take out the filter core then clean with water or detergent.

## Technical Parameter

Voltage: 220V $\pm$ 10% 50Hz/60Hz  
Hydraulic pressure : 0.1~0.2Mpa  
Power of water pump A : 1100 W  
Power of water pump B : 750W  
Power of heat pump : 2000 W  
Power of air pump A : 200 W  
Power of air pump B : 200W  
Bottom light: 12V, 100mA

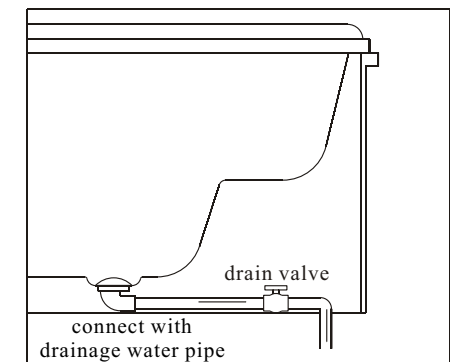
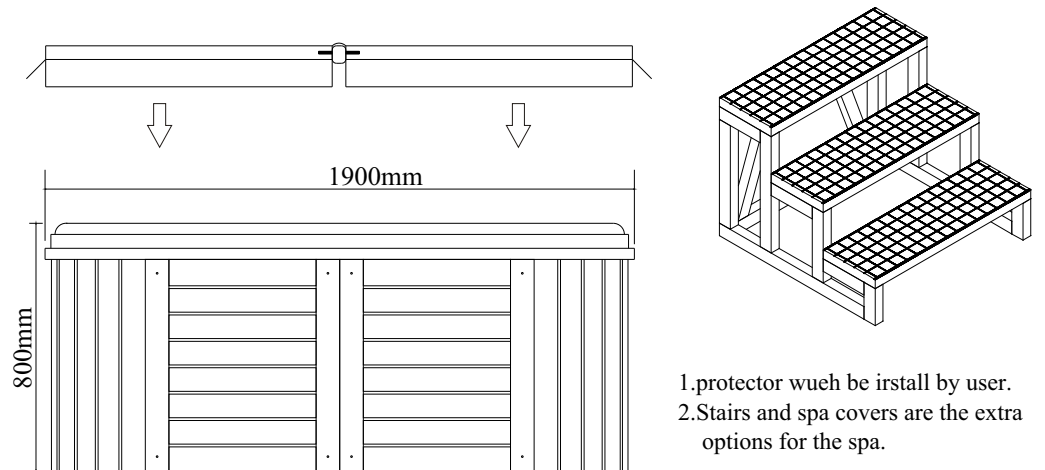
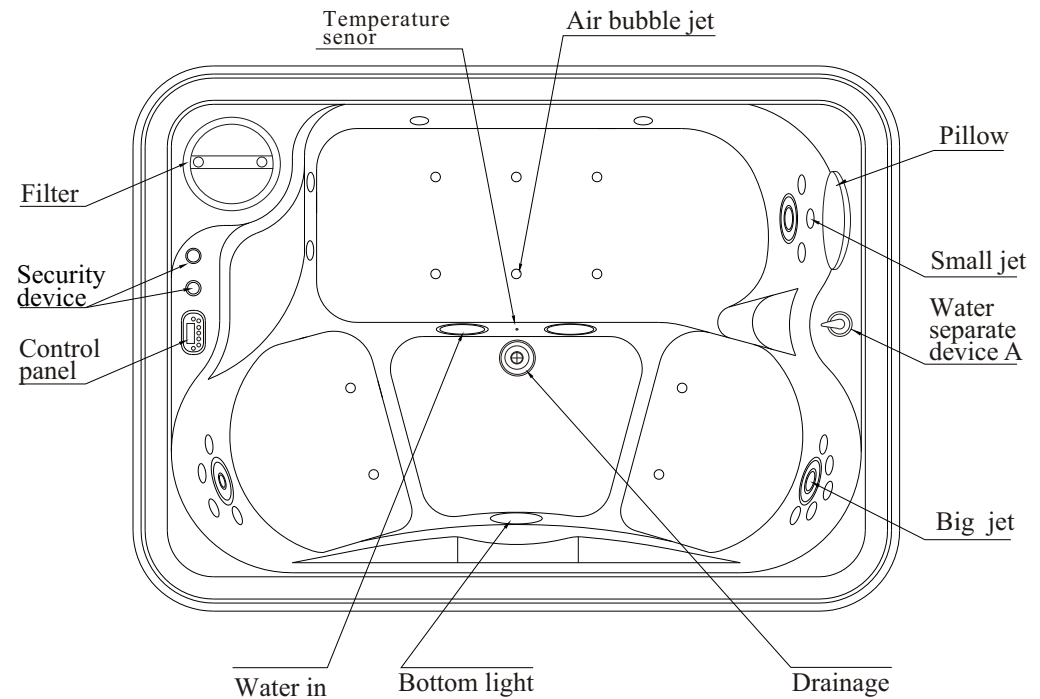

Fig 1

## Troubleshooting

Problems	Reasons	Maintenances
No power or electricity leaking protection device is activated	<ol style="list-style-type: none"> <li>1. Electricity leaking protection device cut off power source when electricity line is not well connected.</li> <li>2. Power or electricity circuit have phenomenon of electricity leaking.</li> </ol>	<ol style="list-style-type: none"> <li>1. check and reconnect the wiring system.</li> <li>2. check the power source, electricity circuit and ground line.</li> </ol>
Water Jets are not working.	<ol style="list-style-type: none"> <li>1. check the system whether is on.</li> <li>2. the impeller of water pump doesn't rotate</li> <li>3. water pump is broken which caused by working without water coming in.</li> </ol>	<ol style="list-style-type: none"> <li>1. turn on the system</li> <li>2. check through and remove the garbage which is inside the pump. Switch pipe can be removed.</li> <li>3. install a new water pump</li> </ol>
The intensity of hydro-massage cannot be adjusted	<ol style="list-style-type: none"> <li>1. water pump's suction has not enough power.</li> <li>2. air adjustment valve is abnormal</li> <li>3. jets or nozzles are blocked</li> </ol>	<ol style="list-style-type: none"> <li>1. check the water pump whether is working normally.</li> <li>2. change the air adjustment valve</li> <li>3. remove things which are blocking the jets.</li> </ol>
Water leaks from the pipes.	<ol style="list-style-type: none"> <li>1. seal ring is broken</li> <li>2. screws doesn't lock tightly</li> <li>3. pipes doesn't seal properly.</li> <li>4. water pipe is broken</li> </ol>	<ol style="list-style-type: none"> <li>1. chang seal ring</li> <li>2. lock the screws tightly</li> <li>3. re-seal the silicone.</li> <li>4. change water pipe</li> </ol>
Control panel doesn't work	<ol style="list-style-type: none"> <li>1. Electricity line didn't connect to power source, electricity leaking protection device cut off power.</li> <li>2. power button is not working.</li> </ol>	<ol style="list-style-type: none"> <li>1. Re-connect the power source and check the electricity leaking switch button.</li> <li>2. change a new control panel</li> </ol> <p>Lighting is off</p>
No lighting	<ol style="list-style-type: none"> <li>1. The bulb is broken</li> <li>2. power line is disconnected.</li> <li>3. control panel is broken</li> </ol>	<ol style="list-style-type: none"> <li>1. change a new bulb.</li> <li>2. re-connect the circuit.</li> <li>3. maintain or change control panel</li> </ol>
Radio is off	<ol style="list-style-type: none"> <li>1. speaker is broken</li> <li>2. power line is disconnected.</li> <li>3. control panel is broken</li> </ol>	<ol style="list-style-type: none"> <li>1. change a new speaker</li> <li>2. reconnect the circuit.</li> <li>3. maintain or change control panel</li> </ol>

## Construction Sketch



SIZE: 1900x1350x800mm